

ALUMASCAPE®
2008



HOLIDAY RAMBLER®

This is Living®









This is Living®







The Alumascape® features Holiday Rambler's exclusive Alumaframe® Superstructure. Our revolutionary system of aluminum H and C-Channel crossmembers runs the entire length of the unit, with double-welded intersections for added strength. This rigid design is both lighter and sturdier than wood or tubular aluminum frames – and much more reliable than butt-welded or screwed joint designs. From dirt roads to potholes, you can count on Alumaframe® to handle the relentless stresses of the road and provide superior structural integrity for many years to come.

- 1** 6,000 lb. Super Lube tandem axles with electric brakes
- 2** Aluminum roof structure with double I-beam roof rafters 16" on center
- 3** 1-1/2" steel-framed sub-floor
- 4** Plenty of room to bring along all your gear in the exterior storage spaces

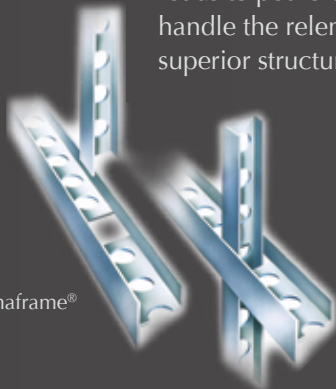

Alumaframe®

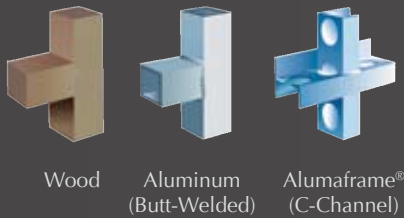

Wood

Aluminum (Butt-Welded)

Alumaframe® (C-Channel)



9-LAYER ROOF (top to bottom)

- Peaked roof with BriteTek™ roof material
- Luaun backer
- Thick, tapered bead foam insulation
- Aluminum double I-beam superstructure filled with fiberglass insulation
- Vapor barrier
- Structure foam: thermal insulative barrier
- Vapor barrier
- Luaun backer
- Vinyl ceiling

STAY COOL ON THE INSIDE

Holiday Ramblers are cooler than other RVs – literally. When put to the test in a thermal chamber, temperatures inside other RVs rose almost 30% more every hour than the Holiday Rambler model.* The secret lies in our exclusive, multi-layer insulation which blocks heat out, keeping the inside nice and cool.

* Test performed by an independent testing facility, Based on measurements taken every 15 minutes.

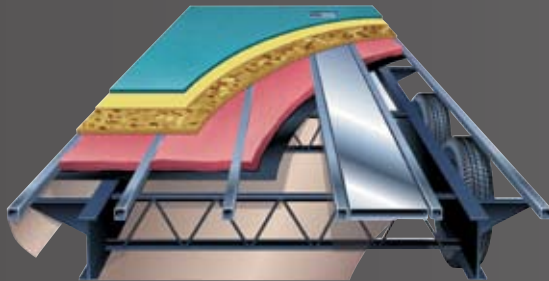
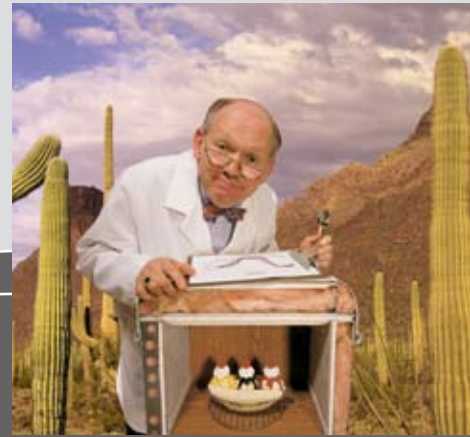

6-LAYER FLOOR: “WORKS IN THE BASEMENT”

The underside of your fifth wheel features a 6-layer floor and a fully enclosed, heated and protective underbelly. The underbelly encloses the wiring harness and fresh water tanks. It helps protect the fluids from freezing and improves the overall insulation of the coach. The underbelly's outer shell is made of rugged

composite material that withstands damage from road debris. By smoothing out the undercarriage, the underbelly provides an unrestricted air flow that results in easier towing and improved gas mileage. In addition, the frame is coated with a rust-inhibiting, electro deposit ion coating.

SLIDE-OUT

When you purchase a Holiday Rambler, you can be sure the slide-out boxes are some of the strongest and most reliable you'll find anywhere. They feature our exclusive multi-layer construction to give you maximum insulation and to reduce the chance of warping, twisting or shifting. In addition, the linear actuator has a mechanical room lock that is built in, and there are adjustable built-in stops for in and out positions.

- A Bearing packs are bolted in 4 places, locking the gear and rack in place
- B A manual crank and extension rod comes standard with every unit, to serve as override if needed
- C Actuator motor is positioned to provide smoother movement and reduce twisting on the slide-out room
- D Alignment mechanism is separate from the linear actuator movement mechanism

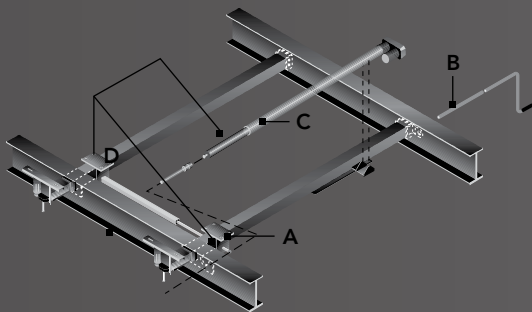

6-LAYER EXTERIOR WALL (left to right)

- Smooth .040 aluminum is standard; high-gloss gel coat fiberglass is optional
- Interlocking C-Channel filled with 1-1/2" fiberglass insulation bonded in place so it doesn't sag or leave spaces uninsulated
- Vapor barrier
- Bead foam adds comfort, saves energy and provides a thermal insulative barrier
- Vapor barrier
- Interior paneling

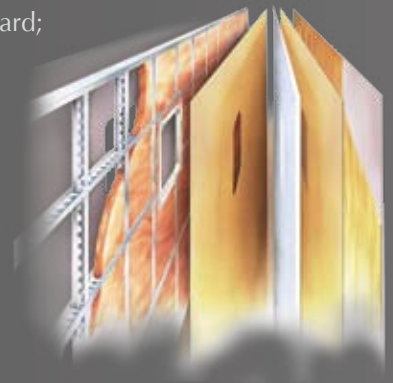



BODY CONSTRUCTION: FEATURES

- Alumaframe Superstructure
- 10" I-Beam Frame
- Smooth .040 Aluminum Exterior Walls
- Front Molded Fiberglass Cap
- Main Slide-Out House, 6'-1" Head Room
- 3/8" Foam Core, Thermal Barrier, Laminated Sidewall Structure
- Rear Bay Cap with Oversized Windows (N/A: 34BHT)
- Prep For Spare Tire
- 1-1/2" Steel Framed Sub-Floor

- Laminated 5/8" Sturdi-Wood Floor
- Laminated Bath Deck
- Aluminum Roof Structure with Double I-Beam Roof Rafter 16" On-Center
- 9-Layer Roof and 6-Layer Sidewall Construction
- Brite TEK™ Exterior Roof Material
- Flat Floor Slide-Out - Main Living Area
- Enclosed and Heated Underbelly
- Insulated Bathroom Floor
- Radial Tires

- Stylized 16" Aluminum Rims
- Ladder
- Stabilizer Jacks
- Shock Absorbers
- Spare Tire with Sport Wheel Recessed into Underbelly

OPTIONS

- High Gloss Gelcoat Fiberglass Sidewalls

APPLIANCES AND ACCESSORIES: FEATURES

- 8 cuft. Refrigerator
- Microwave with Touch Control
- Wedgewood High Output 3-Burner Range with Oven

- Systems Monitor Panel - Battery Charge, Holding Tank Levels, Gas/Electric Water Heater and Water Pump Switch
- Adjustable Pantry Shelves
- Home Theater Surround Sound System

OPTIONS

- 23" LCD TV with HD Tuner and Mounting Bracket

FURNITURE: FEATURES

- Bedroom Slide-Out with Chest of Drawers
- Wood Booth Dinette with End Door and Arched Back Cushions
- Fabric Glider Recliner (N/A: 34BHT)

- Hide-A-Bed Sofa
- Hide-A-Bed Sofa Slide-Out – Roadside (34BHT)
- Swing-up Bunk Bed (34BHT)

OPTIONS

- High Back Desk Chair (32CKQ, 33CKT)
- Free-Standing Dinette Table with Four Wood Chairs

WINDOWS / DOORS AND AWNINGS: FEATURES

- Dark Tinted Radius Windows
- Tinted Skylight in Bathroom
- Patio Awning

- Swing-Out Entry Door Handle
- Window in Stool Room

OPTIONS

- Dual Pane Windows with Dark Tint
- Slide-Out Awning or Cover on Specific Slide-Out Houses

WINDOWS TREATMENTS: FEATURES

- Rear Window with Pleated Day/Blackout Shade (N/A: 34BHT)

- Pleated Day/Black Out Shades in Living Area and Bedroom

ELECTRICAL SYSTEMS AND LIGHTS: FEATURES

- Decorative Wall Light in Living Area
- Water Heater Switch
- Electrical Management System - 30AMP (12V With 55AMP Conv.)
- Two Exterior Security Lights
- Disconnect and Battery Box
- Telephone and Electrical Outlet
- Solar Prep
- TV Antenna with Signal Booster
- Cable TV Hook-up

OPTIONS

- 50 amp Electrical Management Service
- Generator Prep

INTERIOR: FEATURES

- Newport Cherry Cabinets
- Raised Panel Refrigerator Door
- Decorative Slide-Out Room Fascia with Trim and Accents
- Laminate Countertop with Corian Accent Edge
- TV Shelf in Bedroom
- Armstrong Linoleum in Kitchen, Bathroom and Entry Area
- Decorative Glass in Overhead Cabinet Doors

OPTIONS

- Décors: New Latte, Sage Meadow
- Kitchen Countertop Extension - End of Counter Top

PLUMBING AND L.P. SYSTEMS: FEATURES

- Stainless Steel Kitchen Sink with High Profile Single Handle Faucet
- 10 gal. L.P. Gas/Elect. Water Heater
- Bathroom Sink with Brushed Nickel Faucet
- Brushed Nickel Shower Fixtures
- Brushed Nickel Shower Hose and Head
- Shower with Glass Door
- Lighted Water management System with Drain, Spray-Port Water Sprayer with 15' Polyurethane Hose, Outside Shower with Hot and Cold
- Water Heater By-pass Kit
- No-Fuss Flush Holding and Tank Rinsing System
- Two 30 lb. L.P. Tanks with Automatic Changeover

HEATING, VENTS AND AIR CONDITIONING: FEATURES

- 35M BTU Hydroflame Electronic Ignition Furnace
- In-floor Ducted Heating System
- One Carrier 13,500 BTU Rooftop Air Conditioner with Remote Control
- Wire Prep and Ducting for 2nd A/C with Optional 50 amp Service

OPTIONS

- Ceiling Fan
- One Carrier 15.0 High Capacity Rooftop A/C with Remote Control
- Second Carrier 13,500 BTU Rooftop A/C with Remote (Requires 50 amp Service Opt.)
- Attic Fan with Wall Control

ADVANTAGE PACKAGE

- 5 Year Structural Warranty
- Alumaframe Superstructure
- Steel Framed Sub-Floor
- Recessed Spare Tire Carrier
- Alaskan Package (Enclosed and Heated Underbelly, Insulated Alcove Storage Area, 9-Layer Roof and 6-Layer Sidewall Construction)
- One Carrier 13,500 BTU Rooftop Air Conditioner with Remote Control
- Home Theater Surround Sound System
- Disconnect and Battery Box

Due to continuous product improvement, please see the website for the latest in standards and options, specifications, and technical data. Go to www.holiday Rambler.com.



Weights*	29CKD	32CKQ	33CKT	34BHT
Gross Vehicle Weight Rating	14,400	14,400	14,400	14,400
Axle(s) Weight	6,000	6,000	6,000	6,000
Unloaded Vehicle Weight	9,300	10,830	10,520	10,660
Net carrying Capacity (NCC)	5,100	3,520	3,880	3,740
Tire Size and Load Range	16" E	16" E	16" E	16" E
Measurements				
Overall Length	31' 10"	34' 10"	35' 10"	36' 3"
Overall Height (Including A/C)	153"	153"	153"	154"
Exterior Width	98"	98"	98"	98"
Tank Capacities				
Water Heater	10	10	10	10
Grey Tank	40/40	40/40	40/40	40/40
Black Tank	40	40	40	40/40
Fresh Tank	50	50	50	50
L.P. Tank	30 (2)	30 (2)	30 (2)	30 (2)

* Weights may vary by options.

** Tank manufacturer's listed water capacity (WC). Actual filled LP capacity is 80% of listing due to safety shut off required on tank.

The actual overall length of the recreational vehicle may differ from that indicated in the brochure due to variances in the manufacturing process and/or installed components. The actual length may be greater or less than that indicated. Due to the large variety of options and floorplan arrangements available to our customers, actual weights for each unit can differ significantly. Holiday Rambler provides a weight sticker on each unit we produce which includes that unit's tank capacities and approximate weight. Consult your local Holiday Rambler dealer for unit availability and further information. The information printed in this brochure reflects product design, fabrication, and component parts at the date of printing. The manufacturer reserves the right, at any time, to make changes in product design or material or component specifications as its sole option, without notice. This includes the substitution of components of a different brand or trade name which will result in comparable performance. All information printed in this brochure is subject to change after the date of printing. Some features shown or mentioned in this brochure are optional and may only be available in selected floorplans. Photographs may show props or decorations that are not standard equipment on Holiday Rambler models. Holiday Rambler, the Holiday Rambler logo and its design, are registered trademarks. All other products and company names are trademarks and/or registered trademarks of their respective holders. While the color of the motorhome's exterior and the interior fabrics depicted in this sales brochure are fair and reasonable depictions, the colors depicted may not be an exact match of the actual colors because of the variances in photo-processing and variances caused by inserting the photographs within the sales brochure. Due to product improvements, changes during the model year and/or transcription errors that may occur, information represented within this brochure may not be accurate at the time of your purchase. If certain information is significant to your purchasing decision, please confirm the information with your dealer prior to submitting your order. Component part and appliance manufacturers issue limited warranties covering those portions of the recreational vehicle not covered by the Limited Warranties issued by Monaco Coach Corporation. To learn which specific component parts and appliances are excluded from the Limited Warranties issued by Monaco Coach Corporation, please contact your selling dealership or Monaco Coach Corporation directly, or review the warranty packet inside the recreational vehicle.

29CKD

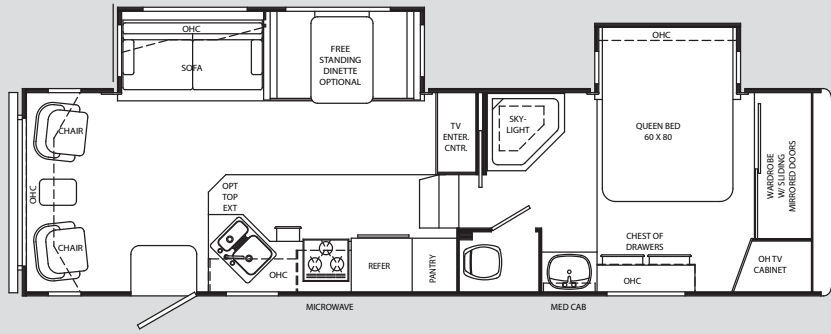

32CKQ

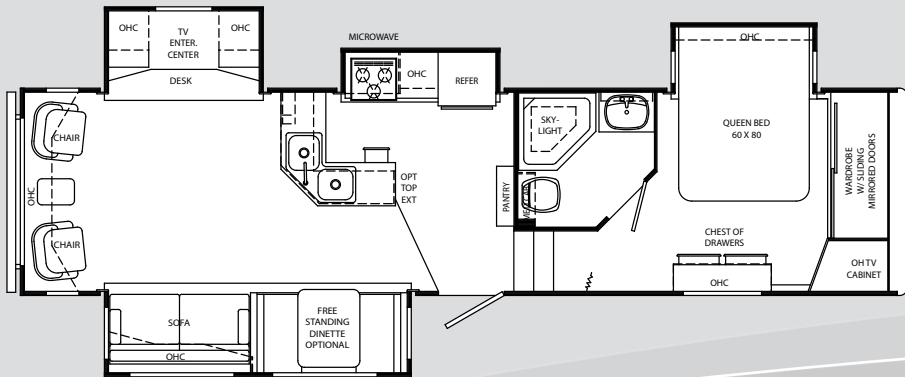

33CKT

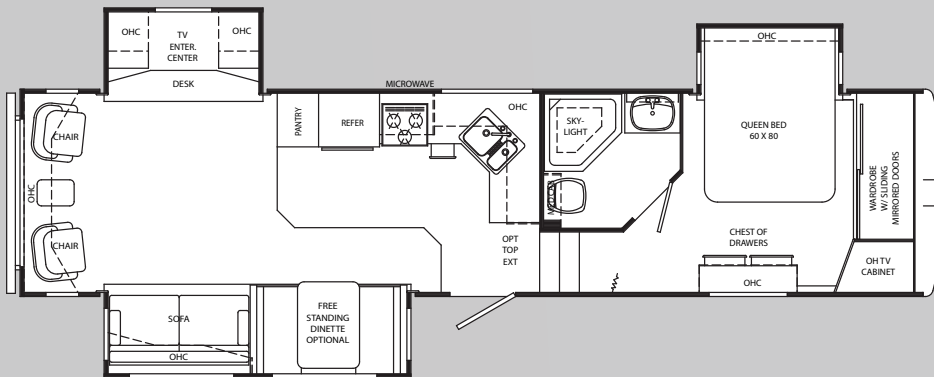

34BHT

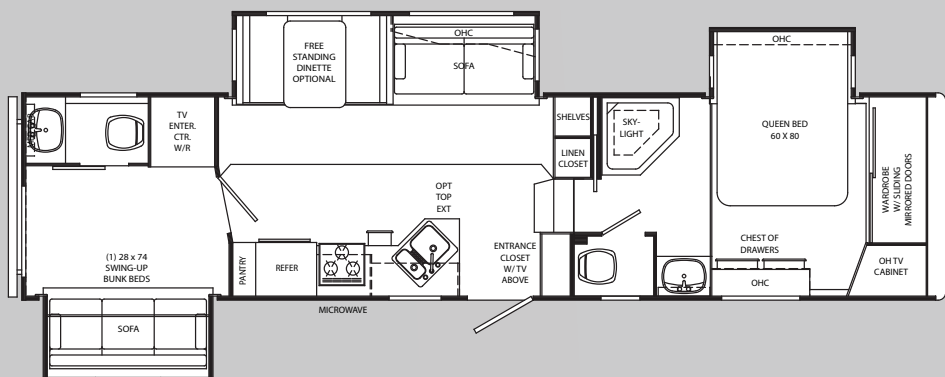



ALUMASCAPE®
2008

BEING DIFFERENT MAKES ALL THE DIFFERENCE.

At Monaco Coach Corporation, we always strive to be the best. And that means thinking outside the box. Giving you more of what you want in an RV. Like our exclusive Roadmaster chassis. PanaSuite™ full-wall slides. And programs like Monaco Financial Services and 24/7 roadside assistance. No other manufacturer can match Monaco's offerings. No one even comes close. Why not discover the difference for yourself? Visit www.monacodifferent.com

**"No other manufacturer can match Monaco's offerings.
No one even comes close."**



WARRANTIES

12 MONTH basic limited warranty

5 YEAR limited warranty on aluminum or steel frame structure of sidewall, roof, front and rear cap

Applies to certain models. See owner's manual for complete details.



24/7
ASSISTANCE
SALES • TECH • ROADSIDE

WE'RE HERE. ANYTIME, EVERY TIME.

- Reach us anytime — literally — via our live customer support line.
- Drive in to one of our 350 Service Centers.
- Enjoy the first year free when you enroll in our Owner Advantage Roadside Assistance Program.
- See where it all begins with a tour of one of our facilities in Indiana or Oregon. Call 1-800-650-7337 or 1-800-634-0855 to find out more.



HOLIDAYRAMBLER.COM

Log on to our website anytime, night or day. It's your link to everything Holiday Rambler, including product news and updates, club events, dealer and service center info and much more. Take it for a test drive today.

606 Nelson's Parkway Wakarusa, IN 46573
www.holidayrambler.com | 800-245-4778



HOLIDAY RAMBLER®

This is Living®



MONACO COACH CORPORATION



Monaco is traded on the New York Stock Exchange under the listing MNC.
© 2007, Monaco Coach Corporation 06/07 HR_08ALUM Litho in USA.